

# IMTS 2016 Booth Previews

## Our guide to the gear stuff

### The Broach Masters Inc.

N-7112

Broach Masters is a manufacturer of broaches, disc shaper cutters, shank shaper cutters, gear shaper cutters, spline broaches, master gears, spline gauges and other cutting tools, made in the USA.

#### For more information:

The Broach Masters Inc.  
Phone: (530) 885-1939  
[www.broachmasters.com](http://www.broachmasters.com)

### DMG MORI

S-8900

This year at IMTS, DMG MORI will be showcasing automation capabilities, especially in the field of gear manufacturing. DMG MORI will display, among others, the NLX 2500 SY, a universal lathe factory installed with a gantry loader, the DMU 40 eVo linear and the DMC 125 FD duoBLOCK.

#### NLX 2500 SY 3-Axis Lathe

The 3-axis lathe NLX 2500 SY with gear machining techniques such as hobbing and broaching will be demonstrated at IMTS. With rigid machine construction and a direct-drive motor in the turret, the NLX 2500 SY is well equipped for such applications. The factory installed gantry loader as well as the second spindle enables an autonomous production and six-side complete machining of high-volume shaft components with gears and splines. The gantry can also be applied to many other types of DMG MORI lathes and even to multi-tasking machines, such as DMG MORI's CTX gamma 2000 TC 2nd Generation.



Pictured: NLX 2000SY

#### DMU 40 eVo Linear Machine

Aside from demonstrating hobbing and broaching, DMG MORI is demonstrating power skiving on the DMU 40 eVo *linear* machine, its universal 5-axis machining center. This one can also be equipped with various automation solutions like the WH 10 and WH 25 part handlers or differently sized pallet handlers. The DMU 40 eVo *linear* will be turning an ID bore and then power skiving an internal gear. Power skiving for larger gears will be demonstrated on a DMU 125 FD duoBLOCK.

At IMTS the DMU 40 eVo *linear* and NLX 2500 SY will demonstrate complete machining of the pre-heat treat operations of the part. Both machines are capable of turning, keyway milling, gear machining, hole drilling and other operations. They are also suitable for the unattended operation by adding various types of gaging and inspection capabilities in the cell.

DMG MORI is taking a solutions approach in providing the customer with not just a high-technology machine but a complete automation solution with integrated systems. DMG MORI's in-house team of automation experts can support all automation needs of its customers.

Apart from these high-volume gear production machines, DMG MORI will also have their line of multi-tasking machines producing gears using other gear manufacturing methods. DMG MORI will also feature their additive-subtractive hybrid machine, LASERTEC 65 3D.

#### For more information:

DMG MORI  
Phone: (847) 593-5400  
[www.dmgmori.com](http://www.dmgmori.com)

### Doimak North America

N-6698

#### RER-G Combi 500 Grinding Center

Doimak will display the RER-G Combi 500 Grinding Center with Fanuc CNC and two wheelheads. Designed for grinding OD, ID and threads, the RER-G is equipped with a fast automatic changing grinding head by means of a rotary base turret, enabling multiple grinding operations in a single setup. The RER series offers a compact design, external/internal thread grinding in fully automatic transition, OD and gear grinding with optional CBN or peeling and b axis for tapers, flexible multi-task grinding, 2-axis contour dress or full form. The machine is available in a two- or three-wheel head design.

Additionally, Doimak recently delivered two REN-T spline and gear grinding machines for the machining of cycloid, helical and spur gears. Doimak tested and delivered these models that included integrated probing technology for gear inspection. The machine inspects gear diameter, run-out or teeth alignment just after grinding takes place, reducing machine setup times and providing a more efficient overall machining process thanks to the integrated inspection technology. The following is a brief rundown of some of Doimak's other machining capabilities:

#### Thread Grinding

Thread grinding machines for all types of threading technology are the product line most representative of Doimak. The latest CNC technology is implemented with built-in drives and linear motors. These machines include a wide range of spindle designs offering optimum stiff-

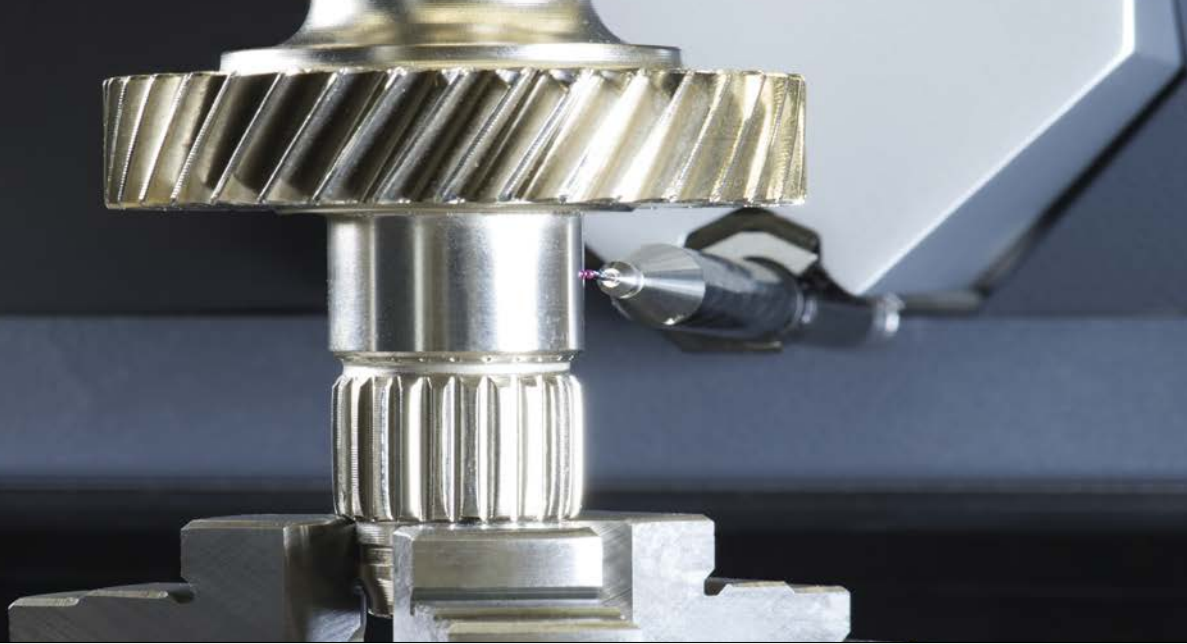

# GEAR MEASUREMENT... EXACTLY

Mahr's Class 1 Universal Gear Testers provide fast, accurate analysis for a wide range of gear and gear tool applications on gears with OD's up to 600 mm (23.6 in). The GMX systems incorporate a high-accuracy scanning probe head, automatic tailstock and powerful controller to make them an excellent solution for both universal and specialized gear manufacturing processes. They also feature ultra-high precision spindles, originally used in the renowned Mahr Formtester series, to allow very accurate form measurements to be made as well. Equipped for both stand-alone shop floor and gear lab applications, Mahr's GMX systems can also be fully networked for fast and efficient transfer of measuring results and machine corrections.

## Dimensional Metrology Solutions for:



AEROSPACE



AUTOMOTIVE



ELECTRONICS



ENERGY



MACHINE TOOL



MEDICAL



OPTICS



**Mahr**

EXACTLY

1-800-343-2050

[www.mahr.com](http://www.mahr.com)



Visit us  
at  
**IMTS2016**  
Booth #  
**E-5614**

Request  
our  
gear  
measurement  
white paper  
[orders@mahr.com](mailto:orders@mahr.com)



▲ MARGEAR GMX 400 W

SURFACE  
MEASUREMENT



SHAFT  
MEASUREMENT



HEIGHT  
MEASUREMENT



CALIPERS &  
MICROMETERS



INDICATORS &  
COMPARATORS



AIR  
GAGING



SNAP  
GAGES



FORM  
MEASUREMENT



PRECISION LENGTH  
MEASUREMENT



ness and damping response. Any type of profile can be dressed thanks to the flexible contour dresser, which also accommodates plunge forming rolls. Multi-ribbed wheels are used for improving process productivity and mass production machines are equipped with robot or gantry type loaders. They offer a higher degree of process automation thanks to different probing and component measuring solutions.

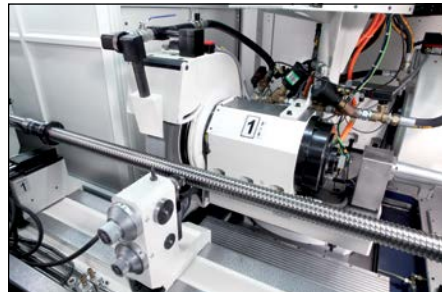

### Cylindrical Grinding

Doimak provides solutions for a wide range of cylindrical shaft grinding applications including extrusion screws and barrels, power generation, printing and more. Different disposition of wheels, including OD/ID solutions with multiple grinding heads mounted in a single swiveling base are available for any type of application requirement.

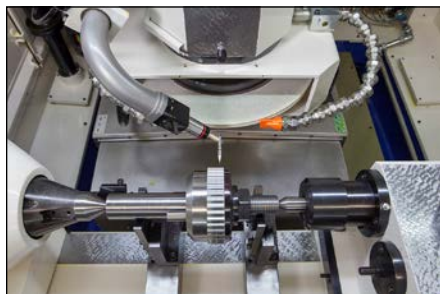

### Gear Grinding

Doimak has also developed several machining solutions for the gear and transmission field. Based on the RER thread grinding platform, straight and helical involute gears can be ground using latest CNC technology which includes built-in drives and linear motors. Involute, as well as cycloidal gear profiles, are automatically calculated according to standard gear parameters.



### Automotive

Doimak provides in-process measuring gauges and high performance tools in order to optimize productivity. Mass production machines can be equipped with robots or gantry-type automatic loaders. In most cases, these machines are equipped with hydrostatic drives in order to avoid wear in moving components minimizing production stops due to maintenance requirements.

### For more information:

Doimak North America  
Phone: (317) 370-2975  
[www.doimak.com](http://www.doimak.com)

## Dontyne Gears

N-7227

Dontyne Gears uses modern technology to improve production and performance of gear systems, including Dontyne Systems software. New for IMTS 2016, Dontyne Systems has announced that its closed-loop gear manufacturing system now includes the ability to export directly to G-Code.

What this means, says Dontyne co-founder Dr. Michael Fish, is that the system can now export gear tooth cutting paths directly to Mazak machines (Booth #S-8300) without the need for intermediary CAD/CAM software.

Dontyne's closed-loop gear manufacturing system was described in depth in the July 2016 issue of *Gear Technology* (page 10).

In addition, visitors to the Dontyne booth can learn about the company's *Gear Production Suite*, a suite of tools for generating design and load analysis models as well as required tooling.

### For more information:

Dontyne Gears  
(859) 803-1191  
[djones@dontyneysystems.com](mailto:djones@dontyneysystems.com)  
[www.dontyneysystems.com](http://www.dontyneysystems.com)

## DTR Corporation

N-7027



Formerly known as Dragon Precision Tools, DTR Corporation will showcase their latest gear cutting tools. DTR has 40 years of experience in manufacturing cutting tools for gear production and specializes in customized hobs, shaper cutters, milling cutters, broaches and master gears, and some of their best samples will be exhibited at the show. DTR offers a complete line of coarse-pitch to fine-pitch tools serving various industries including automotive, aerospace, construction, mining and other equipment industries.

When processing an order, DTR starts by selecting the material based on their collected production data. For example, some customers may find production speed to be the most important factor for mass production, and a tool would need a higher grade material to make sure it can meet customer demands. DTR maintains an inventory of 300 tons of raw materials, which allows them to eliminate delays in production.



DTR's experienced design engineers can review provided gear drawings to make sure the cutter will produce an accurate tooth profile and meet the class requirement, and also maximize the tool life by assigning the right number of gashes for the tool size.





# GMTA NOW REPRESENTING

## RASOMA

Werkzeugmaschinen GmbH

### GERMAN MACHINE TOOLS OF AMERICA (GMTA)

is now the authorized North American representative for **Rasoma**, a builder since 1919 of high-quality vertical turning centers, 4-axis shaft turning centers, end machining centers, double-spindle machining centers and a variety of automated solutions for the automotive and other industries.

The addition of **Rasoma** to our other lines makes **GMTA** a viable partner for nearly every application in the powertrain, gearmaking, bearing and other production line concepts for auto, motorcycle and off-road vehicles, as we bring full application engineering, machine building, laser integration and commissioning to your facility, with single-source support and service from our plants in Ann Arbor, Michigan and Queretaro, Mexico.

Take a look at **Rasoma** and all our lines at [www.gmtamerica.com](http://www.gmtamerica.com). You'll be glad you did.

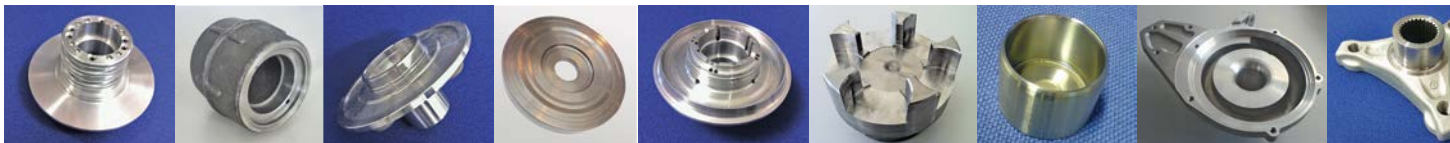

Call Scott Knoy today for all the details.  
734-973-7800





Properly applying the coating and finishing with a smooth surface is another critical step for better tool life. DTR uses their own developed coating machine and surface finishing machine, which ensures the cutting tool has an even surface, which will help reduce the wear amount. Ensuring a smoother surface for cutters will also help reduce the cost of grinding tools for finishing. Lastly, it will help gears have a smoother surface which will contribute to less noise.

**For more information:**

DTR Corporation  
Phone: +82 32-814-1540  
[www.dtrtool.com](http://www.dtrtool.com)

## DVS Technology Group

N-6762

### Buderus Schleiftechnik UGrind Workshop Machine

Buderus Schleiftechnik will be presenting the new Buderus UGrind—a workshop machine designed for efficient and flexible hard finishing of small batches. The machine includes a multifunctional tool revolver for grinding, turning and measuring operations, as well as intuitive operating software with integrated processing and measuring cycles and automatic calculation of the most efficient process strategy.



Depending on the configuration required by the user, the Buderus UGrind carries out external and internal, face and cone surface grinding as well as hard turning operations. The integrated measuring probe controls and monitors machining until the required final dimension has been achieved, which means time-consuming processes such as successive feeding and re-measuring are no longer required.

### Präwema Antriebstechnik Vario Cross Honing

Präwema Antriebstechnik GmbH will be presenting its latest innovation optimizing gearing surfaces—the Vario Cross Honing technology. By using a specially developed oscillation method during the honing process, Vario Cross Honing enables surface roughness to be reduced even further, resulting in another increase in the surface quality of geared components. This innovation allows gearing manufacturers to produce wear- and noise-reduced vehicle gearboxes with higher torque transmission.



### Pittler PV315 Gear Cutter

Pittler T&S GmbH will be presenting the PV315, the latest addition to the PV3 family of machines for complete machining and has been specially adapted to the requirements of commercial vehicle components such as ring gears. Equipped with a multi-function head, Y-axis and tool magazine for up to 20 different machining tools, the PV315 turns, drills, grinds, mills, deburrs and machines internal and external gearing of the quality class IT6 using the efficient power skiving method. This results in a surface quality with an Rz value of less than 2 µm on the tooth flanks as well as a main time three times lower than if the shaping method were used. At the same time, tool costs are reduced since the versatile tool magazine of the Pittler PV315 provides a skiving tool for rough

skiving first followed by a finishing skiving tool, thus significantly extending the service life of the higher quality finishing tool.

**For more information:**

DVS Technology Group  
Phone: +49-69-24 00 08-68  
[www.dvs-technology.com](http://www.dvs-technology.com)

## EMAG L.L.C.

N-6834

At this year's show, EMAG will present its family of turning centers, gear generation machines, grinding, milling, vertical turning and boring equipment, plus advanced electro-chemical and laser welding machines, as well as heat treatment. A variety of machines will be on display in the booth, running under power, plus they'll have experts in all the various technologies they offer, available for discussions. EMAG is a family of global machine companies that includes Eldec, Naxos-Union, Koepfer, Reinecker, Laser Tec, ECM, Kopp and Karstens. The company today often integrates a variety of machines into work cell arrangements at major automotive, off-highway and other power transmission component suppliers.

### VL 4 Vertical Lathe

The VL 4 is a modular vertical lathe with integrated automation, designed for maximum production at low cost per piece with a small footprint. A pick-up spindle moves in the X- and Z-axes with 12 driven tools on a turret to cut and index parts up to 200 mm (7.87") in the shortest time possible. The pass-thru rotary conveyor keeps blanks incoming and machined parts outgoing. Machines can be equipped with a Y-axis for more complex geometries.





### VM 9 Turning, Milling and Drilling Machine

The VM 9 combines turning, milling and drilling into a single machine for large part production. With the workpiece spindle in the bottom of the cutting theatre, the VM 9 offers a turning diameter of 450 mm (17.71"), max workpiece height of 300 mm (11.81") and max workpiece weight of 300 kg (660 lbs).



### VT 2-4 Shaft Machine

The VT 2-4 performs dual-sided shaft machining in high-production mode with dual 11-position tool turrets for fixed or driven tools. Workpieces can be up to 200 mm in diameter (7.87") and 630 mm length (24.80").



# WHY BUY FROM HARDINGE GRINDING GROUP

## SOLUTIONS

The USACH 100-T4 CNC ID/OD precision grinding machine is ideally suited for a variety of different industries. Combining ID, OD, face, taper, radii and contour grinding in one chucking. Thanks to the generous cross axis travel of 500 mm/19.68" (X-Axis), the machine processes parts up to 450 mm/17.7" in diameter at a weight capacity up to 272 kg/500 lbs.

This machine offers a variety of features and options like:

- four motorized grinding spindles
- high precision measuring probe
- latest torque motor based B-Axis design
- automation
- high precision work head swivel B1-Axis
- W-Axis for simultaneous grinding
- Siemens or Fanuc control

Contact us today for more information.



**VISIT US AT**  
**BOOTH #S8738**  
 SCHEDULE AN APPOINTMENT AT  
 MARKETINGINFO@HARDINGE.COM

**CALL TODAY**  
800-843-8801

WWW.KELLENBERGER.NET



**HARDINGE GRINDING GROUP**

KELLENBERGER • JONES & SHIPMAN • HAUSER • TSCHUDIN • USACH • VOUMARD

### Eldec MIND-M 250

The eldec MIND-M 250 is a compact hardening system for basic heat treatment of chucked parts and shafts, provided by the eldec group of EMAG. Heat treatment tasks are performed at 30kW in high frequency applications and 100kW in medium frequency. Workpieces to 10kg (22 lbs).

### Other Products

The EMAG booth will also feature a blisk (bladed disk) display to demonstrate the Precision Electro-Chemical Machining (PECM) technology now offered to the aerospace, pump and power generation markets. In depth, technical videos will be shown at the booth to present some of the other technologies available at EMAG, including the laser welding technology.

### For more information:

EMAG L.L.C.  
Phone: (248) 477-7440  
[www.emag.com](http://www.emag.com)

## Emuge Corp.

W-1536

### FPC Mill/Drill Chucks

Emuge Corp., in partnership with Albrecht Precision Chucks, has introduced high precision/performance Emuge FPC Mill/Drill Chucks that provide increased rigidity, vibration dampening, concentricity, machining speed and tool life versus conventional chuck technologies for milling and drilling applications.

Featuring the world's only chuck with a 1:16 worm gear, Emuge FPC Chuck's design delivers three tons of traction force. The unique design and body provide 100 percent holding power for maximum rigidity, and the collet-cone assembly absorbs virtually all vibration for maximum dampening.



Unique features and advantages include an extremely high transferable torque that provides maximum process reliability (transferred torque on a tool shank diameter of 20 mm is 400 Nm); increased accuracy with a  $3 \times D$  tool length, concentricity is  $\leq 3 \mu\text{m}$  to guarantee long tool life and quality work piece surface finishes; a chuck that is mechanical drive-actuated with a hex wrench, a simple design that enables quick tool change in seconds; a special holder design that reduces vibration, which dramatically improves workpiece surface finishes and provides exceptionally long tool life; and strong clamping force to prevent the possibility of pull-out.

FPC Chucks are designed to be the fastest on the market today. In a speed comparison with four chuck technologies, using a 20 mm end mill in the same material, the Emuge FPC Chuck enabled the feed rate to be increased by 30 percent with no loss in performance.

Emuge FPC Chucks are available in four shank styles (CAT, HSK-A, SK and BT) in 47 different sku's for a wide range of applications. A full range of high precision collets and accessories are also available for the FPC line. Emuge FPC Collets are available in three size ranges (FPC 14, FPC 20 and FPC 25) in over 35 different sku's, from  $\frac{1}{8}$ " to  $1\frac{1}{4}$ " and in metric from 2 mm–32 mm.

### For more information:

Emuge Corp.  
Phone: (800) 323-3013  
[www.emuge.com](http://www.emuge.com)

## Euro-Tech Corp.

W-2453

### Mytec Mechanical Arbors and Chucks



Euro-Tech Corporation's IMTS 2016 product lineup includes MyTec Hydraclamp expansion elements. Mytec is introducing its new line of Mechanical Arbors and Chucks with accuracy down to .0004" plus high expansion rates up to .010" or greater in a stainless steel construction. Mechanical arbors and chucks are excellent for workholding where high forces are incurred or auto load applications where high clearance is required. Mytec elements feature a closed expansion system, which is designed to be impervious to dirt and chips to guarantee a long service life.



### Frenco Spline Gages

Euro-Tech's Frenco spline gage product line provides a quick method of inspecting involute splines, serration splines and straight sided splines to ensure interchangeability of parts even between different manufacturers. Frenco's INO System is an internal standard for the external dimensional measurement of spline gages developed based on national and international standards that is suited to even the most highly sensitive and complex components and systems.

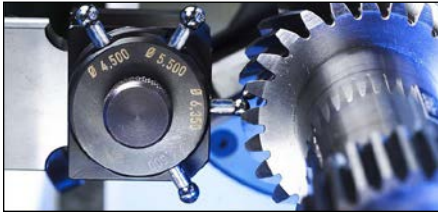

### Kostyrka Clamping Sleeves

Kostyrka slotted clamping sleeve technology is designed to create a shaft-hub joint actuated by hydraulic pressure to efficiently support the workholding function of modern machine tools which users can depend on for reliable operation day after day and year after year.



### PG1000-400S-4K Cutting Tool Inspection Gage

Euro-Tech will be introducing the PG1000-400S-4K cutting tool inspection gage, adding true 4K inspection capability to their PG1000 product line with magnification to 400x and X-micron linear scales. 4K gives you visual resolution of at least four times more pixels than conventional 1080 pixel HD resolution, making it ideal for inspecting micro tools.

### Tschorn 3D Tester

Euro-Tech is adding a new product line in 2016, the Tschorn 3D Tester. The Tschorn 3D Tester stands out with its robust structure and slim and attractive design. Its precise and versatile capabilities enable fast and easy calculation of workpiece reference points and lengths. Probing is possible in all axle directions (X/Y/Z) at the same indicator resolution. As soon as the indicator is at "0," the vertical axis is exactly on the edge of the work piece.

**For more information:**  
Euro-Tech Corp.  
Phone: (262) 781-6777  
[www.eurotechcorp.com](http://www.eurotechcorp.com)

## Foerster Instruments, Inc.

E-4501

Foerster testing systems can verify material properties and heat-treat conditions; detect cracks, chipped or missing teeth in the most intricate of manufactured gears.

Utilizing eddy current technology, Foerster manufactures non-destructive testing (NDT) equipment designed to be incorporated into your current production line.

**For more information:**  
Foerster Instruments Inc.  
Phone: (800) 635-0613  
[www.foerstergroup.com](http://www.foerstergroup.com)

## Gehring L.P.

N-6740

### Lifhone L630 Modular Honing Machine

Gehring L.P. has released the Lifhone L630 — the newest in its line of modular honing machines for precision metal components. Standard part applications that can be honed on the Lifhone range from sun gears to connecting rods, hydraulic sleeves and injector pump components.

The L630 has market-proven components in a modular design. Depending on customer requirements and the product spectrum to be finished, the machine is equipped with matching honing units. The Gehring honing control allows for precision controlled stroke speeds and reversal precision. An optional feature allows the stroke to be executed via a ball screw or a linear motor. The Gehring Operator Panel's (GOP) user friendly and clear graphic interface and the program assistant ease machine operation.

The L630 machine is a honing center that can be equipped with one or two honing spindles. Depending on the machining task and the batch size, this type of machine can be equipped

with a fixed or rotary table and up to eight workstations. Stations can also be used for measuring or brushing operations. The single-spindle version of the Lifhone series has a compact design and small footprint — an advantage to customers with limited space or those who need to frequently change the type of part that needs to be honed.



Gehring will display the Lifhone L630 at IMTS this year, along with its entire portfolio of honing technologies and services, from position and form honing, laser structuring to contract honing and displays of its tooling & abrasives products. Gehring will hold daily technology briefings at Gehring's booth.

A technical presentation titled "Advanced Honing Technology Solutions for Modern Manufacturing" is scheduled for Thursday, September 15, 2016 at 11:00-12:00 in Room N-127 by Michael Schaefer.

**For more information:**  
Gehring L.P.  
Phone: (248) 478-8060  
[www.gehringlp.com](http://www.gehringlp.com)

## German Machine Tools of America (GMTA)

N-6924

### Rasoma Milling, Hobbing and Shaping Machines

Now available from German Machine Tools of America (GMTA), a full line of Rasoma machining centers, includ-



ing vertical turning centers, 4-axis shaft turning centers, end machining, double spindle and various special purpose machining centers with full automation. Gear machines for milling, hobbing and shaping are available in a variety of configurations, and the GMTA application engineering team can assist interested parties to determine the best solution.



Rasoma machining centers offer high rigidity, due to separate X and Z slides, plus the machine head is designed as a monoblock with polymer concrete fill. Thermal stability is enhanced by cooled motor spindles, and the rapid traverse on these centers ranges up to 60m/min at high acceleration, with feed and removal speeds up to 120 m/min, less than six seconds from part to part and turret indexing typically under one second.

Full option packages include robotic handling and part articulation, integrated metrology onboard, working inside or outside the work envelope, full tool measurement and monitoring systems and driven tool packages, all controlled by a single Siemens CNC.

### Samag Machining Centers

Now available from German Machine Tools of America (GMTA), a full line of Samag machining centers, including multi-spindle, horizontal machining centers, deep hole drilling machines and combination milling/drilling machines, is offered for the North American market.



Samag builds a variety of multi-spin-

dle machines, including the MFZ Series for large workpieces, the smaller, modular WBM Series for up to six spindle deep drilling and the combination TFZ Series, which offers users the ability to bore and mill complex cubical workpieces on four sides with a single clamping. On the largest standard machine, large scale moldmaking is possible, with a maximum drilling depth of 2300 mm (over 90"), 65 mm (over 2½") bore and a 50-ton capacity work table.

The company also supplies complete turnkey operations, including robotic articulation, parts handlers and transfer mechanisms for high-production work such as connecting rods and complete machining of differential housings.

### BvL YukonDAK Cleaning System

The BvL cleaning system is the continuous system "YukonDAK." It uses workpiece carriers to transport the goods on a chain conveyor. A light barrier ensures positioning accuracy for the exchange with the automation system.

The system carries out two steps: cleaning through spraying and drying through blowing. The items to be cleaned are crankshaft covers which are produced for a German automobile manufacturer. The parts are washed with a cycle time of 12 seconds and at a temperature between 50 and 55 °C.

The "exhaust air management" developed by BvL reduces the volume of exhaust air which consumes the most energy in a continuous cleaning system. To achieve this, the system measures the moisture content in the drying zone and extracts only as much air from the process as necessary. This creates the best possible moisture level in the system and the volume of hot exhaust air — and therefore energy — blown out of the system is kept as low as possible.

In addition to the energy saving measures, the cleaning system is equipped with a 50 µm dual changeover filter, an air-cooled steam condenser and a mist eliminator.

### For more information:

German Machine Tools of America (GMTA)  
Phone: (248) 921-0122  
[www.gmtamerica.com](http://www.gmtamerica.com)

# Gleason Corporation

## N-7000

Gleason will demonstrate brand new solutions in advanced gear manufacturing technology at IMTS 2016, covering a wide array of processes for the complete production and inspection of all types of bevel and cylindrical gears. Among the technologies to be exhibited are:



### Genesis 260GX Threaded Wheel Grinder

The 200/260GX machines are the most recent addition to Gleason's Genesis machines series. The GX series features a two-spindle concept for maximum productivity with minimized idle and set up times. The 260GX applies the latest grinding process technology featuring twist control and polish grinding for mirror-like surfaces of workpieces. The easy software-guided setup of the machine allows operators to change from one workpiece to another within 20 minutes using only one tool. With the Gleason "First Part Cycle," operators actuate a fully automatic workflow from setup until grinding the first workpiece. Integrated automation made by Gleason, the ability to interface with Gleason GMS machines via QR code and excellent tooling solutions make this machine a comprehensive and worry-free solution from one source.

### Hard Power Skiving

Witness Hard Power Skiving on the Gleason 300PS for the first time at IMTS. Gleason offers a tailored solution to your workpieces, including extraordinarily stiff machines, modular workholding and the right tools to meet the high requirements of the process. The Gleason Power Skiving Simulation Software depicts the cutting cycle for every cut and ensures that cycle times

are minimized and tool life is maximized.

### 500CB Cutter Build Inspection Machine

Another premiere is the 500CB, which is being shown for the first time outside the Gleason premises. The 500CB delivers more accurate and highly automated build, truing and inspection of all types of stick-blade bevel gear cutters with automated closed-loop blade positioning for better gear quality and maximum tool life. The 500CB also automatically controls the tightening of the blade clamp screws, consistently applying the correct torque without the previously required operator intervention.

### Genesis 400HCD Gear Hobbing/ Chamfering and GEMS Software Package

The newest addition to the Genesis line of hobbing machines features a newly developed time-parallel chamfering process. With this new solution, customers will chamfer medium-sized gears more economically and with greater flexibility than ever before. Designed for dry hobbing, the 400HCD exploits the benefits of the latest cutting tools, employing high-speed spindles and a rigid structure. The 400HCD is equipped with the new Gleason Operator Software Package for easy and efficient operation of the machine, including many new features.

### GMSL — Gleason Multi Sensor Metrology System

The brand-new GMSL series of machines offers the latest advancements in metrology systems within a compact and smart design. The new system features six axes of motion for gear and complex form measurement with options like integrated Barkhausen inspection capability and/or surface roughness measurement as well as new, full-form scanning capability. The ability to integrate multiple sensors on a common platform offers the capability of several machines in one system.

### New Tool and Servicing Solutions

Gleason will present its complete gear manufacturing tool program, including modern tool servicing concepts with integrated connectivity via RFID.

Products featured will include tool materials like G90 and advanced carbides, optimized with the latest wear coatings. Power Skiving Tools are now available in solid carbide and with inserted blades for the Hard Gear Power Skiving process. For bevel gears Gleason will show the Pentac Plus RT cutter head, which is designed to make blade setup and checking more reliable and faster than any current solution on the market. Gleason will also present its latest line of hard finishing tools including dressing tools for

grinding and honing applications.

### Advanced Workholding Solutions

Quik-Flex Plus, Gleason's next generation of modular, quick-change workholding systems requires a single tool, less time and minimal operator experience. Customers are invited to stop by and participate in the Gleason Quik-Flex Plus Challenge to experience how easy it is to change the modular components.

Gleason will also demonstrate its line of hydraulic workholding solutions. The

**Gehring**  
Advanced Honing Technology

*lifehone*  
wide range of machines  
for small bore applications

Booth N-6740  
September 12-17, 2016

gehringlp.com

IMTS2016

The advertisement features a large image of a white and black honing machine with a red top section. To the right, there is a stylized American flag graphic. Below the machine, there are several technical drawings of gears and shafts, some with red circles highlighting specific features. In the bottom left corner, there is a QR code and the website address 'gehringlp.com'. In the bottom center, there is a logo for 'IMTS2016' with a green and blue cube icon. In the bottom right corner, there is a red box containing the text 'Booth N-6740' and 'September 12-17, 2016'.

holding force, extreme accuracy and contamination-free designs are well suited for dry gear processing applications. The new Gleason Stir-Able Modular Workholding designs allow off-spindle assembly and truing, reducing change-over time as well as the amount of total run-out in the fixture.

### Gleason Automation Systems with Modular, Integrated Solutions

Gleason Automation Systems specializes in the design and manufacture of factory automation systems serving a variety of customers in the automotive and other industries. Gleason will present the modularity of its automation systems with two different solutions including the compact DS1200 automation unit with integrated secondary processes as an accurate, reliable alternative to costly, operator dependent, conveyor automation. This compact system, which is compatible with most machine tools, uses robotic technology for loading and unloading. Its secondary operations capability allows this system to function as a versatile work cell, further enhancing productivity.

### Gleason Global Services

Gleason Global Services is a leading source of gear technology knowhow and education. Gleason trainers will be promoting the full range of training classes ranging from beginner levels to the most advanced expert topics. Gleason Global Services will present its range of performance upgrades, modernization programs and tooling services, including practical examples.

### Gleason Plastic Gears

Gleason Plastic Gears will showcase its capabilities in plastic gear design and injection molded plastic gears including bevel and cylindrical gears, helical and spur gears, planetary and internal gears. Gleason Plastic Gears provides customers with the benefit of a plastic gear with no weld-line for a stronger, more accurate and economical drive train, eliminating the additional expense of secondary machining. Our experts will be at the show to address all questions you may have.

**For more information:**  
Gleason Corporation  
Phone: (585) 473-1000  
[www.gleason.com](http://www.gleason.com)

## Hainbuch America Corp.

W-1636

### Today—Tonight—Tomorrow Interactive Displays

Hainbuch America Corp. announced the shipment of the first wave of their TTT (Today — Tonight — Tomorrow) Interactive displays to machine tool distributors and OEMs, two of which will be showcased at Hainbuch's 2016 IMTS booth.



These TTT Interactive Displays are fitted with Hainbuch's standard products that are the formation of the Today—Tonight—Tomorrow modular system. To demonstrate the flexibility of the Hainbuch Modular System, the display is equipped with the Spanntop Nova chuck (the original 10-second collet chuck) for turning applications and the Manok plus chuck for stationary applications. The user can experience the simplicity and speed of going from O.D. clamping to I.D. clamping or to 3-jaw clamping in two minutes or less for each change-over. The adaptations included with the display are clamping heads (collets) for O.D. clamping, the Mando Adapt for I.D. clamping and the Jaw module for larger diameters.

The TTT Interactive Display will show end users how they can enhance

the productivity and flexibility of their new machine, thereby improving OEEs and reducing the time it takes to recover their capital investment.

**For more information:**  
Hainbuch America Corp.  
Phone: (414) 358-9550  
[www.hainbuchamerica.com](http://www.hainbuchamerica.com)

## Hardinge Inc.

S-8738

### Hardinge Talent 51 MSY CNC Turning Center



The all-new Hardinge Talent 51 MSY CNC Turning Center will make its debut at IMTS. This machine features the Hardinge quick change Collet-Ready Spindle, which offers better part accuracy and surface finish capabilities as compared with conventional spindles. The machine also comes standard with live tooling, sub spindle and Y-axis designed to meet the most demanding machining challenges and allow for part-complete operations. The Talent 51 MSY features a 5,000 rpm 25HP main spindle with 2" bar capacity. It offers a turning diameter of 12.2" and a maximum turning length of 24.9". The 12 station turret uses 3/4" square shank and 1 1/4" round shank tooling and 6000 rpm maximum live tooling capability is standard. The turret also provides 1/2 station index for up to 24 tools. The machine is offered with a Fanuc 0i-TF control packed with a host of standard control features.



## Hardinge Conquest H51



The Hardinge Conquest H51 will be displayed with a newly released hydraulically-operated steady rest. This new attachment is the ideal tool to support long workpieces without distorting or deflecting the part. The machine features a 20hp, 5000rpm and a 2-6" main spindle with a 2" bar capacity. It offers a maximum turning diameter of 12.3" and a maximum turning length of 25.5". The 12 station turret offers ½ station index for up to 24 tools. The machine offers a wide variety of standard features such as through-tool coolant, bar feed and chip conveyor interfaces, three position stack light, PCMCIA memory card, USB Capability, rigid tapping and many others, including state-of-the-art machine crash protection.

## Bridgeport XT 630 5-Axis Vertical Machining Center



On display for the first time is the new Bridgeport XT 630 5-Axis Vertical Machining Center. This new-generation machining center is a fully-digital, high-quality machine tool, designed to achieve maximum capacity and performance in the aerospace, mold and die, medical and automotive industries, as well as many other manufac-

turing sectors. This machine has been developed to meet the demands of the most demanding metal cutting user. Manufactured from quality sourced gray cast iron to the highest standards, the Bridgeport XT 630 5-Axis is packed with features. The machine is offered with a sophisticated yet user-friendly Siemens 840D-SL control with a 19" LCD. Axis travels are X: 762 mm (30") Y: 630 mm (24.8") and Z: 600 mm (24"). Standard machine equipment includes Big Plus CT40 spindle, 15,000 rpm direct-cou-

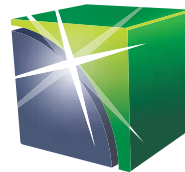

# IMTS2016

International Manufacturing Technology Show  
September 12 - 17, 2016 · McCormick Place · Chicago

## FORM MEASUREMENT

*Now With Unprecedented Speed & Accuracy*

Checking surface form accuracy of finished parts while still in the machine, no longer requires multiple-touch, long cycle time routines using a touch probe. Working in conjunction with the machine to scan the part's profile in one continuous motion, the new Marposs G25 gauge accurately measures surface form to within 0,4 µm repeatability at speeds up to 1500 mm/min.

The compact, shop-floor hardened G25 gauge enables you to rapidly verify part surface form accuracy on a variety of ground or turned parts with a minimum of downtime. Plus, you can use the same device to perform touch functions for determining part location and alignment. Learn more at 1-888-MARPOSS or marposs.com



**MARPOSS**



IMTS2016 See us at IMTS - Booths E-5516 & S-8719

pled spindle with oil chiller, coolant chip flush system, three color stack light, 40 tool swing-arm ATC, pre-wiring for Renishaw part probe, through-ball screw chiller, preparation for through spindle coolant (with a rotary union) and A & C axis encoder.

### Additional Machines and Tooling

In addition, Hardinge will have on display the Bridgeport Conquest V480 APC Vertical Machining Center with integrated automatic pallet changer, the Bridgeport Conquest V1000, the Kellenberge Varia Universal Cylindrical Grinding Machine, the Usach 100-T4 CNC Grinding Machine, Hardinge Quick-Change FlexC Collet Systems, Hardinge Sure-Grip Expanding Collet Systems and Hardinge Swiss-Style Collets and Guide Bushings.

### For more information:

Hardinge Inc.  
Phone: (800) 843-8801  
[www.hardinge.com](http://www.hardinge.com)

## INDEX Corp.

S-8136

### G220 Turn-Mill Center

The new INDEX G220 Turn-Mill Center includes a motorized 5-axis 18,000-rpm (max) milling spindle and a tool turret with Y-axis, providing maximum machining flexibility for turning and milling complex parts in a single setup from bar stock up to 90mm diameter, chuck diameter 210 mm. Distance between spindles is 1280 mm, maximum turning length is 1000 mm. Users in the precision parts industries including automotive, aerospace, and mechanical engineering will benefit from the high-accuracy done-in-one capability of the machine.



INDEX will demonstrate the machine cutting bevel gears from bar stock at IMTS 2016. The cutting method is similar to the Klingelnberg gear generating method and makes use of the G220's

Y-B axis provided in the milling head. According to INDEX, the process is ideal for smaller, 0.6 to 4 module, bevel gears as it can produce high quality gears — front and back — faster than conventional bevel gear machines. The G220 can also produce other type of gears as well as other complex precision parts due to its versatility.

The fluid-cooled, identical main and counter spindles provide power of 31.5/ 32 kW (100%/40%), a torque of 125/170 Nm and a maximum speed of 5000 rpm.

The fluid-cooled five-axis motorized milling spindle (power 11 kW, torque 19/30 Nm, speed up to 18000 rpm) has hydrostatic bearings in the Y/B-axes. The stable circular guide further ensures excellent rigidity and damping. The Y-axis features a  $\pm 80$  mm stroke. The B-axis driven directly by a torque motor has a swivel range of  $-50$  to  $+230$  degrees. With a large travel distance in the X-direction, machining at up to 30 mm below the turning center height is possible.

The motorized milling spindle operates using a one or optionally two-row tool chain magazine which features space for 70 or 140 tools (HSK-A40). The double-row tool magazine enables setup during machining time.

A tool turret located in the lower part of the machine can accommodate VDI 25 and VDI 30 tool mountings in 18 or 12 stations, respectively, all of which can be equipped with individually driven tools (power 6 kW, torque 18 Nm, speed 7200 rpm).

The compact machine features a CNC-controlled programmable gantry-type removal unit for finished workpieces. It can unload remnants from the main spindle as well as finished parts from the counter spindle. The G220 offers a generous work area, so operators have easy access to the main and counter spindles, the turret and the motorized milling spindle, as well as the operating panel.

The G220 utilizes the latest generation of the INDEX C200 SL controller. Based on the Siemens Sinumerik 840D sl (solution line), it features an 18-inch touchscreen. The operating panel can do more than just operate the machine. It features a second input which INDEX uses for its own Virtual Machine (VM) program

simulation (optional). By pressing a button, the operator can switch to “VM on Board” and make use of simulation, irrespective of current machine operations.

### For more information:

INDEX Corp.  
Phone: (317) 770-6300  
[www.indextraub.com](http://www.indextraub.com)

## Kapp Technologies

N-7036

Kapp Niles will feature three machines at the International Manufacturing Technology Show (IMTS).

### KX 100 Dynamic Gear Center

The KX 100 Dynamic gear center is uniquely designed for mass production of external planetary gears up to 125 mm. Its independent twin “pick-up” work spindles provide much more than optimum productivity. Tooling setup time is drastically reduced, work arbor change and verification is automated, and grinding worm change is semi-automated. The KX 100 will be exhibited as a turn-key solution with “basket staker” automation and tooling. An integrated pallet conveyor (pictured) offers a robust solution for considerable space and cost savings. “The KX 100 machine is already being used in the automotive market with great success,” said Bill Miller, vice president of sales at Kapp Technologies, “and we are excited to show this machine at the show.”

### ZE 800 Gear Profile Grinding Machine

Kapp Niles’ ZE 800 Gear Profile Grinding Machine will be on display to highlight its capability of internal grinding and measuring of high helix internal gears up to 40 degrees. The ZE 800 (and ZE 400) are known for compact, ergonomic and productive solutions for a range of profile grinding applications up to 25 module (1 NDP). Software and HMI are intuitive, making setup fun and reliable.

### PGM400 Measuring Machine

Kapp Niles will also unveil the new PGM400 measuring machine from

Penta Gear Metrology. The PGM400 extends Penta Gear's smaller ND165 and ND300 machines. Speed and precision are outstanding on the PGM400. Windows software has been developed for easy setup and analysis.

A wide array of Kapp non-dressable CBN tools for profile grinding, DIA dressers for threaded wheels, superfinishing tools and DDG for honing will also be on display.

Kapp Niles continues to lead with the expansion of manufacturing solutions that streamline entire processes with intuitive, automated and integrated systems. This is complemented by the measuring machines from Penta Gear Metrology, and the larger custom measuring machines from R&P Metrology, which offer the high quality and precision Kapp Niles is known for. For more information:

**For more information:**  
Kapp Technologies, LP  
Phone: (303) 447-1130  
[www.kapp-niles.com](http://www.kapp-niles.com)

## Klingelberg

N-6827

### C 30 Bevel Gear Cutting Machine



Due to ongoing advancement of the vertical concept, the Oerlikon bevel gear cutting machine C 30 is designed to set new standards in dry processing. All machines in this series are equipped with a thermostable, vibration-dampening machine bed. An optimized axis arrangement also ensures reduced approach paths, and thus significantly less load on the drive components, and a more rigid design of the overall system. Moreover, an integrated deburring tool enables maximum productivity and utmost process safety through the use of the Pulsar method.

### P 40 Precision Measuring Center

The fully automatic CNC-controlled precision measuring center is designed as a compact unit for the workpiece diameter range up to 400 mm. At the heart of the P 40 is an accurate, durable rotary table. Configured as a measuring axis (C axis), it provides concentric seating of the workpieces to be tested.



All precision measuring centers are now equipped with new versions of the calibration software and an advanced graphical user interface. The new Windows user interface, soon to be established on the market under the "EasyStart" brand, allows the machine operator to operate the machine in a manner that is both significantly easier and target-oriented. A clearly structured user interface, displayed by a tiled layout with appropriate symbols for the specific measuring application, ensures a quick and easy program start on the gear measuring machine. Most machine operators will already be familiar with this type of application from the current general Windows system interface.

### Optimized Small Batch Production

The industrial gear unit sector comprises many different applications, all of which place great demands on the reliability of gear wheels. The cylindrical gears for these sectors are often produced by companies specializing in small batch sizes and a variety of products. A stiff machine design and flexible, cost-effective tool systems are the keys to success for ranking among the market leaders in these sectors. With the Viper 500 machine variants, Klingelberg has developed a modular technology platform that gives con-

tract gear manufacturers in particular a leg up on the competition thanks to maximum process efficiency and unparalleled production quality.

### Viper 500 W Cylindrical Gear Grinding Machine

The Viper 500 W cylindrical gear grinding machine is designed for component diameters up to 500 mm and specifically for small to medium-sized batches. To suit individual requirements, the machine is available in three different configurations: profile grinding, small grinding wheels for custom jobs, and multiple-wheel technology (K) as well as generation grinding (W). The Viper 500 W configuration allows both profile grinding and continuous generation grinding on the same machine with minimal retooling time.



On all variants, the optional internal gear grinding arm allows retooling from external to internal gearing. Moreover, the special machine axis arrangement is a contributing factor in the machine's tried-and-tested precision and consistent quality, as well as tremendous flexibility. The highly dynamic axes allow optimized 5-axis machining of an entire range of modifications in the shortest possible grinding time.

**For more information:**  
Klingelberg America  
Phone: (734) 470-6278  
[www.klingelberg.com](http://www.klingelberg.com)



# Koepfer America

N-6918

Koepfer America will feature several new pieces of technology at IMTS 2016.

## Model 200 CNC Gear Hobbing Machine

The Koepfer Model 200 CNC gear hobbing machine will be shown with new, advanced software for the hobbing of non-circular gears. This type of gear demands complex calculations and formulas for the hobbing process, and Koepfer engineers are readily available to adapt any feasible convex contour. Pump motors and other specialized applications make use of non-circular gears to ensure precise nonuniform transmission of motion.



## CLC 100-SZ CNC Gear Shaping Machine

Also at IMTS, the CLC 100-SZ CNC gear shaping machine will be demonstrated. This highly customizable machine offers an extensive feature set. In detail, this new 120 mm (4.724 in) diameter machine offers heavy duty construction, direct drive torque motors, up to 2,000 strokes per minute, up to 100 mm (3.937 in) of stroke length, a moving saddle, optional tilting column, orientation probe, electronic helical guide and CNC relief. Additionally, this feature-packed shaping solution is available with twin work spindles, which allow easy loading and unloading of a part simultaneously with the shaping of another work piece. Consequently, machine chip-time can be maximized. Gear manufacturers will discover in the CLC 100-SZ a workhorse for both job shop flexibility and volume production.

## Monnier + Zahner 500 D-Drive CNC Gear Hobbing Machine

The newly introduced Monnier + Zahner (MZ) 500 D-Drive CNC gear hobbing machine will also be on display at IMTS. This hobbing solution features a double drive system for flexible clamping of workpieces with less tail-stock pressure, which is ideal for ultra-fine-pitch parts. The machine also offers optional automatic loading and unloading, hob shifting, deburring, a small footprint, and a cost-conscious design.

Lastly, Koepfer America will show Helios gear cutting tools and Tyrolit hard finishing tools. Gear manufacturers can also visit the Koepfer America booth to learn more about Wenzel CNC gear inspection machines, the KFS CNC gear tool sharpening machine, and the latest available used equipment. For all gear manufacturers, Koepfer America is a top choice for machine and tool solutions.



**For more information:**  
Koepfer America, LLC  
Phone: (847) 931-4121  
[www.koepferamerica.com](http://www.koepferamerica.com)

# Liebherr Gear Technology, Inc.

N-6930

## LGG 280 Gear Grinding Machine

With a one-table design and a new-design grinding head, the new Liebherr LGG 280 gear grinding machine greatly reduces grinding times for twist-free profile and generating grinding of workpieces to 280 mm diameter.

Presented for the first time in North America at IMTS, the machine is the second in the LGG series and is designed to deliver consistently high large-scale production quality in automotive applications, including conical gearing. With it, manufacturers can produce smaller gears with greater load-carrying capability. (See the full presentation of the machine at [www.youtube.com/watch?v=b2PG1GJPRUE](http://www.youtube.com/watch?v=b2PG1GJPRUE))



According to a Liebherr spokesman, "With this series of space-saving machines, vehicle manufacturers can develop a complete production line, in which all gearing components for a passenger vehicle transmission can be ground: planetary and sun gears, bore-type gears, as well as drive and pinion shafts with lengths up to 500 mm."

The advantage to the one-table solution is higher quality throughout the entire production. There is one clamping fixture, one geometry. Every machined part is manufactured under the same conditions for high reproducibility. The one-table approach provides the statistical capability and reliability in continuously producing controlled  $\mu$ -range finish quality for gear noise optimization.

The new grinding head allows for rotation speeds up to 10,000 rpm and has spindle power of 35 kW. With this performance data, the head enables high cutting speeds and high feed rates.

The new grinding machine can exploit the considerable potential of the innovative 3M abrasive Cubitron II. Changing the grinding arbor with HSK-C 100 tool holder is a fast and simple process. Also available is a second grinding head for

featuring a small worm diameter for collision-critical parts.

The machine will enable undulations to be applied specifically to gear wheel flanks for noise optimization purposes for the first time. The ability to produce sub- $\mu$  range waviness cost-effectively gives designers a whole new range of optimization options.

The touch screen user interface on the machine control permits easier, intuitive programming and machine operation and incorporates an integrated web-cam. The control also can incorporate substantial additional documentation, such as fixture layouts and tool mounting instructions.

The LGG machines are easily coupled with Liebherr automation solutions to create a fully automated production line for the highest quality gears in the least possible cycle times.

**For more information:**  
Liebherr Gear Technology, Inc.  
Phone: (734) 429-7225  
[www.liebherr-us.com](http://www.liebherr-us.com)

## LMC Workholding

W-1314

LMC Workholding will display a variety of its workholding product line, including face drivers, wheel chucks, cylinders, steady rests, specialty workholding products and more. Also displayed will be a new chuck, from LMC's new partner Rotomors of Turin, Italy. This extra-large chuck is an automatic self-centering, down-clamping and indexing chuck.



The FRB face drivers on display feature a patented mechanical compensating system, which is highly adjustable and reliable in the most difficult conditions. Work positioning is maintained with optimal repeatability. The use of centers with slots also allows turning of pipe, or workpieces with holes in the end.

Hydraulic and manual steady rests will also be exhibited. Atling self-centering steady rests maintain the integrity of shaft or bar workpieces that tend to bend or deflect under unstable cutting loads. LMC Workholding/Richter manual steady rests are manufactured to customers' applications, from small standard, ring style and special steady rests to large, complex units.

LMC also offers specialty workholding with Stiefelmayer clamping solutions for highly specific applications. The product line consists of workholding chucks and mandrels with integrated hydraulic compensation and other special clamping tools.

**For more information:**  
LMC Workholding  
Phone: (574) 735-0225  
[www.LMCworkholding.com](http://www.LMCworkholding.com)

## LMT Tools

W-1732

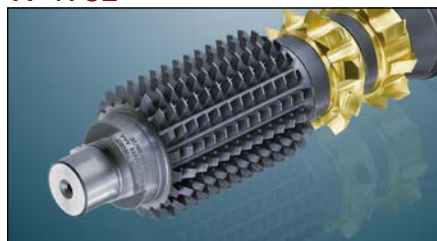

For decades LMT Tools has been an expert in producing cutting tools for the production of gears, focusing on optimized productivity and increased cutting speeds in industrial manufacturing. Being technologically advanced, LMT Tools offers a wide tool range for gear cutting in the market. The product range includes small-module and large-module tools for the roughing and finishing of gears.

In 2010 the company launched Nanosphere, the world's first nanostructured multilayer coating for gear hobs. This high-tech coating protects tools against the extreme conditions of the machining process.

For hobs and involute gear cutters with indexable inserts, LMT Tools developed Nanotherm, a heat resistant coating which protects blades against the high temperatures that occur during the milling of large gears.

Working with a manufacturer of gear cutting machines, LMT Tools devel-

oped the ChamferCut tool system that enables users to carry out gear cutting and deburring in a single work process.

LMT Tools' most recent hob development bears the name Speedcore. The special feature of this tool is its intermetallic core, which facilitates significantly higher cutting speeds.

As a partner for complete gear production systems LMT Tools offers users in the automotive and wind energy industries a comprehensive range of products and services, from initial tool procurement to tool reconditioning.

**For more information:**  
LMT USA, Inc.  
Phone: (847) 687-5924  
[www.lmtusa.com](http://www.lmtusa.com)

## Luren Precision

N-6960

LGA-2812 Continuous Generating Gear Grinding Machine for Gear Class AGMA 14



Luren brings you the all new LGA-2812 CNC continuous generating gear grinding machine. LGA-2812 is built on a Reishauer NZA, AZA machine base, utilizing an advanced Siemens Sinumerik 840D CNC controller, high-speed workpiece spindle, and grinding wheel spindle. The Luren-designed and -created gear grinding software acts as an interface between Luren grinding machines and the Siemens 840D controller. Minimal CNC experience is necessary to operate this machine.

Other features include a Swiss made NUM controller, a Windows-based operating system, an 8-axis control system, a single diamond rotary dresser and optional automation. The LGA-2812 is equipped with high speed spindles. The workpiece spindle operates up to

600 rpm. The grinding wheel spindle operates up to 5000 rpm.

### Luren LFG-3540 Horizontal Gear Profile Grinding Machine for Gear Class AGMA 14



Luren Precision has developed the high-precision LFG-3540 CNC gear profile grinding machine. With a firm machine base of one-piece casting, direct drive motor with zero backlash and closed-loop optical scale for feedback control, the LFG-3540 makes high precision gear grinding a reality with a maximum capability of 400 mm in outside diameter. The LFG-3540 also has a powerful software function that allows flexible definitions of gear data and processing conditions. Fine tuning on gear profile, lead and pressure angle can be easily achieved based on measurement results. The LFG-3540 is designed to be a CNC gear profile grinding machine with one of the best performance-to-price ratio in the market.

Features include a combination direct drive motor and linear motor, special profile grinding for spur gears, pump gears and helical gears, automatic stock dividing, a point or rotary diamond dresser and on-board inspection capabilities.

### Matrix Model 0550 External Thread Grinding Machine



The Matrix Model 0550 features a servo motor driven work head, a Siemens

840DE CNC control, a motorized wheel head, a coolant clarification system, automatic wheel balancing, a centrifugal separator, a programmable helix, a magnetic separator, absolute encoders fitted on all configured axes, a spindle chiller unit, a manual tailstock, a totally enclosed hood, a work head mounted dresser, a fume extraction system, a remote diagnostics system, air conditioning (ECC), one diamond dressing media, two MT work centers, one grinding wheel, one test grind (customer) part and the Matrix Profile MATE Software. Installation and commissioning is also available.

#### For more information:

Luren Precision Chicago Co., Ltd.  
Phone: (847) 882-1388  
[www.lurenusa.com](http://www.lurenusa.com)

## Mahr Federal Inc.

E-5614

Mahr Federal will feature the MarShaft Scope 250 Plus, the new MarShaft Scope 600 Plus 3D, and the MarGear GMX 400 at IMTS 2016. Also on display will be several custom gaging solutions developed by the MarSolutions Engineered Metrology Team.

### MarShaft Scope 250 Plus Optical System

Mahr Federal's MarShaft Scope 250 Plus flexible optical system for shop floor measurement is competitively priced and designed to provide fast, accurate, fully automatic measurement of smaller shafts and turned parts directly on the shop floor. It features a highly accurate matrix camera with four million pixels, and measures parts up to 250 mm in length and 40 mm in diameter. Its MPE (Maximum Permissible Error) of less than 1.5 microns +L/40 when measuring diameter and 3 microns +L/125 when measuring length is more accurate than other systems using line cameras.

### MarShaft Scope 600 Plus 3D Optical/Touch Sensor

The new MarShaft Scope 600 Plus 3D, introduced at this year's Control Show, will also make its debut appearance at IMTS 2016. Combining optical and touch

sensors in the same unit, the MarShaft Scope 600 Plus provides 3D functionality and complete inspection of the workpiece in a single measurement. In a matter of seconds, the matrix camera optically measures characteristics such as diameter, length, radius, shape, location characteristics, etc., while a new 2D sensor detects features that are not optically measurable, such as cam lift on concave cam profiles and reference (clocking) features such as holes or keyways.

### MarGear GMX 400 Universal Gear Tester

The MarGear GMX 400 is a Class 1 Universal Gear Tester that provides fast, accurate analysis for a wide range of gear and gear tool applications on gears with ODs up to 400 mm (15.75 in). Part of the Mahr Federal GMX Series, the GMX 400 incorporates a 4-axis Power PC controller with automatic tailstock and a high-accuracy 3D scanning probe head. The GMX 400 provides an excellent solution for both universal and specialized gear manufacturing processes.



The GMX Series is designed to provide maximum precision and flexibility of gear and form measurement in a single system. Equipped for standalone shop floor or gear lab applications, the GMX 400 can also be fully networked for fast and efficient transfer of measuring results and machine corrections. The GMX Series provides Class 1 accuracy in accordance with VDI/VDE 2612/2613 Group 1.



## MarSolutions Engineered Metrology

Mahr Federal will also be exhibiting a wide range of its MarSolutions Engineered Metrology Team capabilities. Custom gage stations will reflect the three levels of design solutions available from Mahr Federal, including modified standard product gages, gages configured from Standard Elements, and gages custom built for the application. Also, reflecting industry's drive to automation, MarSolutions examples will demonstrate manually operated gages, semi-automatic solutions, and fully automated robotically loaded gaging stations -- thus providing the full range of custom design solutions from the MarSolutions Team.

### For more information:

Mahr Federal Inc.  
Phone: (401) 784-3100  
[www.mahr.com](http://www.mahr.com)

## Marposs Corp.

E-5516, S-8719

### Mida Diamond Touch Probes and Tool Setters

Marposs will introduce its new Mida Diamond line of high precision machine tool touch probes and tool setters at IMTS 2016. The Mida Diamond line has been developed to assist in controlling the entire production process in all its phases: from work-piece set-up and inspection to tool pre-setting and control. The high precision products address industries that require high accuracy controls on very complex surfaces such as aerospace, biomedical and dental, mold and die production, and micro-manufacturing applications.



Mida Diamond Touch Probes for part checking are designed to guarantee exceptional measuring performance thanks to piezoelectric technology. The probes are available with various trans-

mission methods including wired transmission, optical transmission and radio transmission.

The Mida Diamond Visual Tool Setter (VTS) for tool checking implements a vision technology using a video camera to detect tool dimensions, in particular those of micro-tools, and for complex measurements. VTS can be used together with dedicated measuring software, for checking a wide range of tools, guaranteeing repeatability of less than 1µm.



Advantages of the new Mida Diamond probing line include reduced machining and checking times, increased production efficiency, reduced production rejects, and constant machining quality level during the entire production process.

### For more information:

Marposs Corp.  
Phone: (248) 370-0404  
[www.marposs.com](http://www.marposs.com)

## Mitsubishi Heavy Industries America Inc.

N-7046

Mitsubishi supplies a wide variety of gear manufacturing machines, including hobbing, shaping, shaving, grinding and gashing machines, along with related cutting tools.

### For more information:

Mitsubishi Heavy Industries America Inc.  
Phone: (248) 669-6136  
[www.mitsubishigearcenter.com](http://www.mitsubishigearcenter.com)

## Nachi America Gear Tools Division

W-2245

Nachi America will be presenting their newest coating release. GX coating for broaching and GP coating for hobs.

GX - Ensures consistent accuracy and improved wear resistance with long tool life with both water soluble cutting fluid and water-immiscible cutting fluid.

GP - Coating Suitable for both dry and wet hobbing Supports a wide range of machining environments and methods Exhibits the best performance in conventional cutting range (Cutting speed 80 to 180m/min)

### For more information:

Nachi America Inc. Gear Tools Division  
Phone: (317) 530-1004  
[www.nachiamerica.com](http://www.nachiamerica.com)

## Norton/Saint-Gobain Abrasives

N-7051

### Norton Century45 Centerless Bond Platform

Norton/Saint-Gobain will feature Norton Century45 centerless grinding wheels at IMTS 2016. The newly developed Norton Century45 centerless bond platform features an exclusive chemistry that greatly improves grain retention in the wheel. Better grain retention means wheels are constructed with more porosity for a given hardness. This translates into wheels having a hard grade with the performance of a softer grade, providing a range of benefits.



Norton Century45 wheels are available with ceramic, aluminum oxide, silicon carbide grain and abrasive blends to maximize user grinding safety and efficiency. These wheels reduce cycle times by up to 50 percent, improve stock removal by over 30 percent and increase wheel life from 30 percent to 100 percent versus standard products currently on the market.

Norton Century45 provides a continually sharp wheel face that achieves over 30 percent more stock removal, reducing grinding times through fewer passes to achieve optimal results.

Operators will generate more parts through reduced production cycle times when using Norton Century45 wheels.

Norton Century45 centerless grinding wheels also can decrease grinding noise levels by as much as 23.2dB, even when grinding hard-to-grind alloys such as Inconel 718, thus increasing operator safety. To put this noise reduction in context, many commercially-available foam ear plugs offer Noise Reduction Ratings in the range of 25 to 28dB.

Norton Century45 is ideal for bar grinding, fastener and tool grinding, automotive or aerospace components, as well as bearing applications. Whether in a high production grinding facility or job shop, Norton Century45 can significantly reduce grinding costs while increasing safety and production throughput.

**For more information:**

Norton / Saint-Gobain Abrasives  
Phone: (508) 795-5626  
[www.nortonabrasives.com](http://www.nortonabrasives.com)

**Oelheld U.S.  
Inc.**  
N-7475

**SintoGrind IG 540**

Oelheld's SintoGrind IG 540 grinding oil is designed for flute grinding, profile grinding and outside and inside diameter grinding. SintoGrind IG 540 works on a wide variety of materials including tungsten carbide, HSS, PCD, CBN, cermet and ceramics.



Features of the SintoGrind IG 540 include protection against cobalt leaching, low foaming, high-quality surface finish, superior ageing, excellent flushing and cooling properties, low evaporation and misting and a high flash point. The SintoGrind IG 540 is also physiologically safe and is designed to have a pleasant odor.

**ToolGrind TC-X 620**

Oelheld has introduced ToolGrind TC-X 620 as its high performance grinding oil. ToolGrind TC-X 620 incorporates the additive technology from Oelheld's flagship product SintoGrind. The product is designed for flute grinding, profile grinding and outside and inside diameter grinding. ToolGrind TC-X 620 works on a wide variety of materials including tungsten carbide, HSS, PCD, CBN, cermet and ceramics.

The TC-X 620's features are identical to the IG 540's: protection against cobalt leaching, low foaming, high-quality surface finish, superior ageing, excellent flushing and cooling properties, low evaporation and misting and a high flash point. The ToolGrind TC-X 620 is also physiologically safe and is designed to have a pleasant odor.

**SintoGrind TC-X 630**

SintoGrind TC-X 630 is designed to be Oelheld's new entry level product to its flagship SintoGrind series. SintoGrind TC-X 630, with its new base oil technology, is designed for flute grinding, profile grinding, and outside and inside diameter grinding.

SintoGrind TC-X 630 works on a wide variety of materials including tungsten carbide, HSS, PCD, CBN, cermet and ceramics. SintoGrind TC-X 630 was especially formulated for demanding grinding tasks and delivers exceptional feed and speed rates with superior surface finish. Its lubricity lends to extended wheel life and minimal heat build-up, which in turn eliminates surface cracks and burns.

**For more information:**

Oelheld U.S. Inc.  
Phone: (847) 531-8501  
[www.oelheld-us.com](http://www.oelheld-us.com)

**Oerlikon  
Balzers**

**W-2380**

**Balinit Altensa**

The Balinit Altensa is the newest product in the successful AlCrN family that stands out through its wear resistance and hot hardness. The coating properties at high temperatures were specifically targeted for optimization. "Essentially, we further reduced the thermal conductance and improved the hot hardness of the coating by a good 20 percent," explains Wolfgang Kalss, head of marketing and product management for cutting tools. This has led to even higher resistance to crater wear, which can occur particularly at high service temperatures and reduces the useful life of the tool.



Moreover, the abrasive wear resistance was optimized by about 35 percent as was the oxidation resistance. This reduces the flank wear at moderate and high cutting speeds and it yields a longer tool service life, even with dry machining. The numerous improvements in layer development enable considerable productivity gains with longer tool lifetimes, significant performance boosts at the highest cutting speeds for all substrates (PM HSS, MC90, carbide) as well as higher cutting speeds and feeds. Customer tests with various gear-cutting applications yielded corroborative results.



The versatility of Balinit Altensa is also proven in lubricated machining, in which initial results demonstrate a significant increase in service life.

Tests by an automotive supplier demonstrated that productivity can also be clearly improved for carbide stick blades. At a cutting speed increase of 35 percent to  $vc = 200$  m/min, a 30 percent improvement in service life was also achieved at the same time. Another automotive supplier tested coated HSS shaper cutters (diameter of 130 mm) in lubricated machining and the tools lasted 140 percent longer.

**For more information:**

Oerlikon Balzers  
Phone: (800) 792-9223  
[www.oerlikon.com/balzers](http://www.oerlikon.com/balzers)

# Reishauer Corp.

N-7040

The Reishauer Group, with its two companies, Reishauer and Felsomat, highlights its combined gear manufacturing process: from blanks to perfectly ground gears.

## FHC 80 Hobbing Center

Felsomat offers all the manufacturing steps from soft turning to hobbing, laser welding, hard turning and a wide range of material handling solutions, from gantry loaders to robot cells. At IMTS, Felsomat will showcase the flexible hobbing center FHC 80. This machine has been specifically developed for the high-speed cutting of automotive transmission gears. In combination with an ultra-rapid integrated loading system, it is possible to achieve machining times of less than 8 seconds per workpiece with a minimum of floor space and a maximum of work area. Chip-to-chip times are below one second due to the loading and unloading taking place in parallel to the hobbing process and due to the twin-spindle system that eliminates non-productive time, all of which lead to low costs per piece. The FHC 80 has been designed for dry cutting and achieves a final quality of IT4 to IT5 with a single cut or a dressing cut process. Furthermore, and synchronous to the main processing time, the machine features push-roll-deburring with a fettling wheel and the elimination of the resulting secondary burr.



## RZ260 Gear Grinder

On the Reishauer side, an RZ260 gear grinder equipped with two work spindles will be shown off. As soon as one workpiece is ground, the turret swivels around by 180 degrees so that the machine can immediately start grinding the next part. The twin-spindle arrangement eliminates the idle time between grinding cycles. While one workpiece is being ground, the other is simultaneously meshed and oriented into the correct grinding position. To complement its range of machines, Reishauer produces its own grinding wheels, workholding and diamond dressing rolls. In this way, the company can truly guaran-

tee that all elements of the grinding process—the machine and the tooling—are fully under control.

The complete gear manufacturing process is supplied from within the Reishauer Group. If customers embark on a new project, they can rely on partners that understand all the elements that make up the gear manufacturing process; partners who can supply all the technology from machines to process parameters, grinding wheels, diamond dressing rolls, fixturing and material handling. In their field of activity, Reishauer and Felsomat guarantee the proper functioning of all these elements of the complete gear manufacturing solution.



**For more information:**

Reishauer Corp.  
Phone: (630) 629-7531  
[www.ksa-inc.com](http://www.ksa-inc.com)

# Schneeberger J. Corp.

N-6936

## Aries NGP Tool Grinder

The latest addition to the machine offerings from Schneeberger, the new Aries NGP, answers to the need for an affordable tool grinder with all the power of the big machines. Aries NGP offers almost 10 Hp duty rated power with the direct drive double ended spindle and the accuracy of HSK50 wheel arbor interface. The machine has been designed to fit even in the smallest space, barely 3 feet wide and just over 5 inches deep, the machine offers a 10" x 10" work envelope, integrated coolant, and powered by Schneeberger Quinto Qg1 software, the only CAD tool programming software creating tool programs in



seconds. All this made possible by the reliability and accuracy of the FANUC 31 series control system. The machine is perfect for sharpening hobs, shaper cutters, straight or spiral and any other tool.



### Norma NGC Tool Grinding Machine

The Norma NGC is Schneberger's universal 5-axis tool grinding machine for both production grinding and tool servicing. It offers a complete contingent for full automation: 7-station integrated wheel pack loader with coolant manifold, integrated tool loader and the ideal corresponding clamping systems for any tool type. Equipment with the new Zenon 3D probe measures wheel forms as well as tool geometries. The grinding spindle delivers full 13 Hp (at 100 percent) with extreme torque for highest stock removal.



The rigid and compact 5-axes kinematic is designed to assure best grinding results. The open structure and accessible utility compartment enables for easy and quick PM on the hydraulic and pneumatic components of the machine. The Fanuc 31i B5 control guarantees fast and accurate positioning of the machine axes and is marketed for its reliability and longevity.

The machine stands out in energy savings due to the automatic switch

off of several user components after the last machine function has ceased. The machine reduced energy consumption by 92 percent in standby mode.

The specific machine application range and accuracy allows for manufacturing or sharpening of a variety of tools, such as end mills drills inserts, hobs, shaper cutters and a wide range of other tools. The Norma NGC has been designed to be one of the most universal machines in the market.

#### For more information:

Schneberger J. Corp.  
Phone: (847) 888-3498  
[www.schneberger-us.com](http://www.schneberger-us.com)

## Seco Tools

### W-1564

#### Square T4-12

With larger insert sizes, Seco's T4-12 line of square shoulder and helical milling cutters allows parts manufacturers to achieve increased depths of cut and higher metal removal rates when roughing and semi-finishing steel, cast iron and other workpiece materials.

The bigger inserts all come with four curved cutting edges that lower tooling cost per part and ensure smooth machining operations. They tangentially mount in the cutter bodies for increased performance stability and easier access to their mounting screws. Plus, this mounting design directs cutting forces to the thickest part of the inserts, which contributes to their higher metal removal capability.



Cutter diameters for the larger T4-12 square shoulder inserts range from 1" to 5" (25 mm to 125 mm), with corner radii up to 0.125" (3.1 mm). Diameters for the larger T4-12 helical inserts range from 2" to 4" (50 mm to 100 mm), with corner radii up to 0.125" (3.1 mm). The inserts also come in a wide selection of grades and geometries as well as in normal and close pitch versions.

### Highfeed 6

Seco's new high-performance Highfeed 6 milling cutter easily tackles a variety of difficult-to-machine materials from stainless steel to heat-resistant superalloys. The large-diameter cutter bodies are capable of 0.070" (1.8 mm) axial depths of cut and feature double-sided inserts with six cutting edges for unsurpassed material removal and low operating costs.

### Niagara Stabilizer 2.0

The Niagara Stabilizer 2.0 next-generation — STR-430 and STR-440 Series — solid-carbide end mills offer metal removal rates double those of their predecessors. Also, with twice the chip load capacity, the new versions shorten part machining cycle times and further boost productivity.

The end mills come in diameters from 0.125" to 1.0" with square corner and corner radii, based on series and diameter, of 0.010", 0.020", 0.030", 0.060" and 0.120". Lengths are 1xD, 2xD and 3xD, and shanks are either cylindrical or have Weldon Flats.

### TP grades (Duratomic)

Incorporating Seco's Duratomic Technology, TP2501, TP1501 and TP0501 turning grade inserts feature the company's Chrome Used-Edge Detection, making it easy to avoid insert waste without sacrificing tool performance.

The TP2501, TP1501 and TP0501 inserts offer an expanded choice of solutions for workpieces in the ISO P materials category of steel as well as additional applicability in stainless steel and cast iron. With a broad working range, the TP2501 grade provides dependable productivity and reliable part production in most steel-turning applications. TP1501 is a general grade with well-balanced properties for applications that require high wear resistance and excellent surface finish in low-alloy carbon steel workpieces.

### TK grades

Additional Duratomic-technology-based Seco grades that will be at IMTS are the company's TK1501 and TK0501 grades designed for exceptional performance in cast iron turning. The inserts

are tough, wear resistant and process more parts per edge. The Duratomic coating expands their application range while increasing overall tool life and productivity through a balance of toughness and hardness for the highest performance. Both TK1501 and TK0501 also feature Chrome Used-Edge Detection to minimize waste.

**For more information:**

Seco Tools  
Phone: (248) 528-5200  
[www.secotools.com/us](http://www.secotools.com/us)

# SMW Autoblok Corp.

W-1400

## Chuck Changing System

At IMTS 2016, SMW Autoblok will be introducing the Chuck Changing System (CCS) to the North American market. Designed for quick changeover of workholding on CNC turning machines, standardized adapter parts allow the use of different kinds of workholding (for example 2-jaw chucks, 3-jaw chucks, collet chucks, mandrels and manual fixtures) with the same system.



Changing a chuck with CCS takes minutes. A turn of the key connects any workholding device to the machine spindle as well as to the drawtube of the actuating cylinder. The hardened and precision ground CCS and adapter parts ensure the highest repeatability and changeover accuracy. A large through hole and a visual control for the locking status add to the unit's versatility. The CCS can be installed onto new machines or can be retrofitted to any existing CNC lathe.

The CCS is now available for ASA spindles A6, A8, A11 and for cylindrical spindles for diameters Z170, Z220, Z300.

**For more information:**

SMW Autoblok  
Phone: (847) 215-0591  
[www.smwautoblok.com](http://www.smwautoblok.com)

# Solar Manufacturing

N-6358

Solar Manufacturing will be introducing a new, innovative and more thermally efficient hot zone design at IMTS 2016 in Chicago. Recent successful tests of a new graphite insulation board in the hot zone of an existing furnace promises exciting results compared against existing insulation materials used in current hot zone designs. It is more thermally efficient and extremely strong and durable.

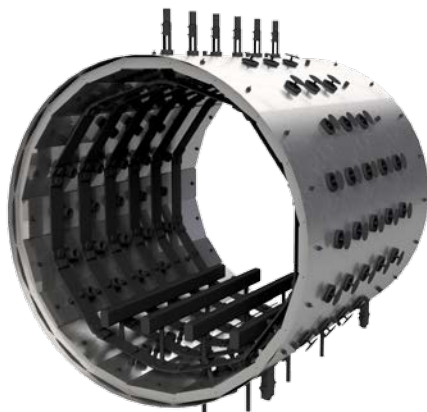

Solar Manufacturing will also be showing off their other furnace lines. Models ranging from compact lab furnaces, mid-size horizontal production furnaces, large car-bottom furnaces, and vertical bottom loading furnaces.

**For more information:**

Solar Manufacturing  
(267) 384-5040  
[www.solarmfg.com](http://www.solarmfg.com)

# Speedgrip Chuck

W-2194

## Quick Change Adapter System

Speedgrip will be showing their new Quick Change Adapter System. Merging

the tested and true Camlock adapter type with today's carrier and receiver system is designed to provide a solution that is accurate, fast, and affordable.



Setting up is quick. The Camlock adapter "receiver" is placed on the spindle. A receiver and retention knob retainer is attached to the jaw chuck, collet chuck and face driver and you are ready to go. To change chucks, simply release the cam studs, move the drawtube forward, remove one chuck, slide on the other, tighten the studs, retract the drawtube, and in 5 minutes you have a completely different chuck and are ready to go. Users can change from a jaw chuck to a collet chuck in less than 5 minutes, from a collet chuck to a face driver in less than 5 minutes and then back to a jaw chuck in less than 5 minutes.

The Quick Change Adapter System is more affordable than Curvic coupling quick change adapters and available in sizes A-5 to A-15. As an additional feature, the drawbar sub-assembly that can be adapted for either draw tube or drawbar.

**For more information:**

Speedgrip Chuck  
(574) 294-1506  
[www.speedgrip.com](http://www.speedgrip.com)

# Star SU LLC

N-6924, W-2258

Star SU will have two booths again this year — one in the gear pavilion in the north hall and another in the west hall showcasing cutting tool technology.

## Booth N-6924

Product overviews, video displays and Star SU's new interactive customer application guide solution tool for Star SU's full line of product and technology offerings. IMTS visitors can explore independently or have a Star SU representa-

tive guide them through the company's complete machine tool, cutting tool and tool services offerings from the brands they represent, including Star Cutter Company, Samputensili, Bourn & Koch, SICMAT, Profilator/GMTA, FFG Werke (Huller Hille, Hessapp, Modul, VDF Boehringer), H.B. Carbide and Sandvik Coromant.

### Samputensili SG 160 Sky Grind Gear Dry Grinding Machine (N-6924)



Star SU offers the Samputensili SG 160, the first gear dry grinding machine in the world that can grind gears without using coolant. This evolution of the gear generating grinding process ensures short cycle times, even less than traditional machines (less than 2 seconds). Watch a video demo, learn more about the machine and plan to visit Star SU's exhibit by going to their dry grinding page.

### Bourn & Koch 400 H CNC Horizontal Hobbing Machine (N-6924)



Bourn & Koch 400H 7-Axis CNC Horizontal Gear Hobber features Fanuc CNC control and an industry exclusive point-to-point array hobbing capability. Ideal for longer spline shafts, spur and helical gears up to 400 mm diameter, 6.4 max module. For more information, visit Star's 400 H horizontal hobbing web-

page. Request a budget quote and plan to see it at IMTS by visiting Star's 400 H horizontal hobbing webpage.

### FFG Werke Modul H200 Vertical Hobbing Machine (N-6924)

The H 80/100/130/160/200 series is the latest version of Star's hobbing machine line for small automotive applications. These machines have been designed for dry cutting applications in particular, although using oil or emulsion is not a problem. Chips are conveyed cleanly from the work area by means of a chute, which is steep and smooth in design to prevent any build up. The hob head is housed within the tool column, which is tightly fastened to the sturdy machine bed. The tailstock is located on the tool column above the hob head, leaving the work area free for workpiece loading and unloading operations.

## Star SU Gear Cutting Tool Solutions

N-6924, W-2258

Star SU carries a wide variety of new gear cutting tools and offers precision tool re-sharpening services and advanced coatings, including Oerlikon Balzer's New Balanit Altensa, the high-speed coating solution that realizes productivity gains and efficiency. Need more help managing your tool room? Let Star SU monitor the life cycle of your tools and re-sharpen, re-coat and replace them as needed. Visit [www.star-su.com/cutting-tools/gear-cutting-tools](http://www.star-su.com/cutting-tools/gear-cutting-tools) and request a meeting with Star to discuss how they can help you with your gear cutting operation.

Star SU will also feature Scudding cutters in conjunction with GMTA and Profilator manufactured to produce gear and spline teeth for reduced cycle times and tool costs. Learn more by visiting us at IMTS or going directly to Star's scudding page.

### Gundrills (W-2258)

Star SU carries a full line of gundrills and deep hole drills, including single flute gundrills, solid carbide single flute gundrills, two-flute two-hole gundrills, double jet gundrills, double crimp gundrills and bi-tip gundrills.

### Solid and Brazed Construction Carbide Drills & Reamers (W-2258)

Star SU offers a wide range of precision solid carbide drills and reamers, including solid and braze construction carbide drills and reamers, core drills, Super Round Tool (SRT) reamers, valve guide reamers, multi diameter cavity machining tools and cryogenic machining cutting tools.

### Carbide Blanks and Preforms (W-2258)

Star SU offers a wide variety of tungsten carbide blanks and preforms from H.B. Carbide. Using only quality raw materials and employing state-of-the-art, computer controlled vacuum furnaces and vacuum sinter-hipping furnaces, these cemented carbide preforms can be used for cutting tools, dies and wear parts in a variety of specialized applications.

#### For more information:

Star SU LLC  
Phone: (847) 649-1450  
[www.starsu.com](http://www.starsu.com)

## Suhner Industrial Products

W-1474

Suhner manufactures spiral bevel gears using the palloid, cyclo-palloid and HPGS "hard cut" cyclo palloid methods. In addition, visitors can learn more about Suhner's flexible shafts and electric motor products.

#### For more information:

Suhner Industrial Products  
Phone: (706) 235-8046  
[www.suhner.com](http://www.suhner.com)

For Related Articles Search

IMTS

at [www.geartechnology.com](http://www.geartechnology.com)



# Vargus USA

W-2446

## Gear Milling System

At IMTS 2016, Vargus USA will launch a standard line of indexable and solid carbide gear milling tools for a wide range of gear, spline and rack manufacturing applications. These high precision tools are suitable for machining straight and helical Class 11 AGMA gears ranging from DP 128.0-4.0, ANSI B92.1 involute splines ranging from DP 48/96-4/8 and ISO 14 straight splines. Vargus solid carbide tools range from DP 52-13, and are an excellent solution for machining close to a shoulder. The Vargus Gear Milling System is easy to set up on standard 3.5 axis CNC milling machines and produces a minimum of 50 percent reduction in cycle time compared to traditional hob milling.

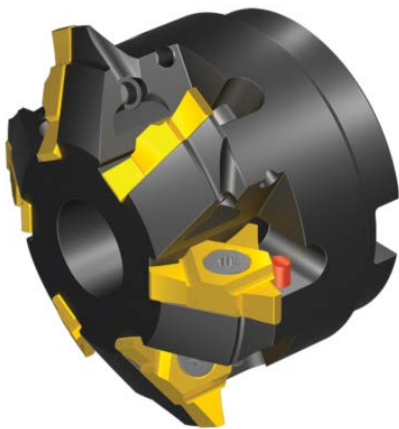

### For more information:

Vargus USA  
Phone: (800) 828-8765  
[www.vargususa.com](http://www.vargususa.com)

# Zoller Inc.

W-2022

## HobCheck Gear Hob Measuring Machine

The Zoller hobCheck brings an expanded range of possibilities and solutions to the table with the ability to measure gear hobs according to standards with high accuracy and easy programming, using intuitive data entry and parameter selection.



Conventional gear hob measuring machines only measure hobs in a very rigid way using an old-school, tactile approach which is literally “blind.” The Zoller hobCheck opens the eyes to a new level of tool inspection with the ability to measure small hobs that were previously not measurable. For hobs under a certain size, the conventional touch probe alone cannot measure all required parameters, e.g. line of action. The touch probe simply can't reach all required locations on the teeth of the hob. However, this can easily be achieved with an optical approach, and furthermore it's important to note that the camera system tilts in accordance with the lead angle.

Specific characteristics can be re-measured based on the interactive report. Simply select the reported dimension, then the machine positions the tooth in question into field view and allows the user to clean the tooth and proceed with the re-measurement.

»hobCheck« now opens the door to measuring a huge variety of other cutting tools. Examples are form milling cutters (gear milling cutters, rack milling cutters, any free form), (indexable) worm milling cutters, including

the ability to generate the actual form cut into the part, shaper cutters, coupons, endmills, drills, reamers, turning tools, inserts, PCD mono block tools, indexable tools and (form) grinding wheels. Unlike a tactile approach, with Zoller's vision system you can determine and document edge wear to minimize removal during regrind.

With the *metis* software module, simple measurements in the camera view can be undertaken at any time and can be processed in a manner of a 2D computer-aided design (CAD). This can be the examination of a chipped edge or a quick angle or radius measurement. Full documentation in form of PDF, WinWord or Excel reports is available for further data processing.

While conventional hob measuring machines simply hold the tools between centers, this is just one option on the »hobCheck«. All tool holding solutions on the market are also possible (for example, HSK, Capto, CAT, KM and straight shank automatic hydraulic chucks).

As an accessory to the hobCheck, the pomSkpGo can measure the edge hone. Both machines share a database so that a complete report on macro and micro geometry on the edge preparation is possible. The ISO9000 certified hobCheck enables a high-level of reverse engineering of any cutting tool, so it's an excellent instrument for research.

### For more information:

Zoller Inc.  
Phone: (734) 332-4851  
[www.zoller-usa.com](http://www.zoller-usa.com)

# STILL NOT ENOUGH?

For even more IMTS  
booth previews, visit  
[www.geartechnology.com](http://www.geartechnology.com)